

Salient Features

- Fast Action
- Compact, light weight & vibration free
- Versatile
- Energy efficient
- Low cost

Typical Applications

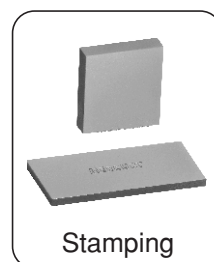
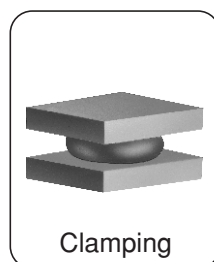
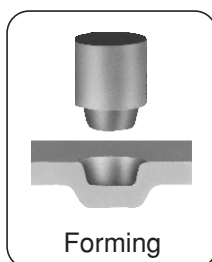
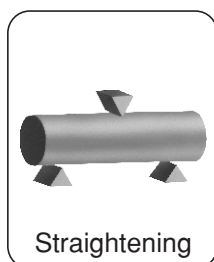
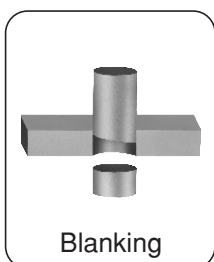
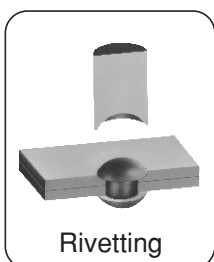

Press Cylinder Dimension

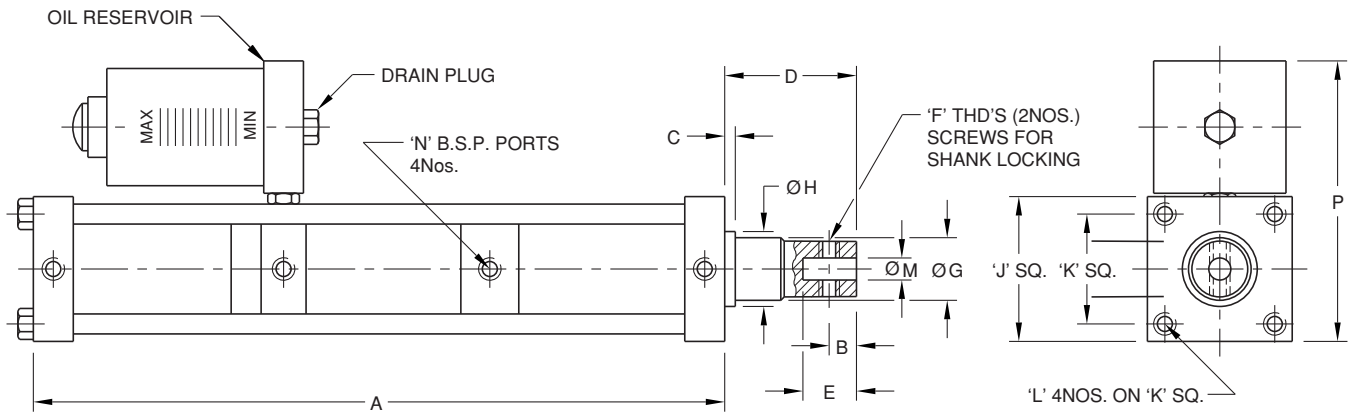

TO CALCULATE COMPRESSOR POWER CAPACITY

1HP = 120 LITRES OF FREE AIR (NL) PER MINUTE AT 5 Kg/Cm²

N = NUMBER OF CYCLES PER MINUTE

Q= FREE AIR CONSUMED PER CYCLE (FROM CHART) IN NORMAL LITRES (NL)

$$\text{POWER REQUIRED} = \frac{Q \times N}{120} \text{ (H.P.) OR } \frac{Q \times N}{120} \times 0.746 \text{ (KW)}$$

MODEL NO.	TON	TOTAL STROKE	POWER STROKE	A	B	C	D	E	F	ØG	ØH	J SQ.	K SQ.	L	M	N	P	Q (NL)
M014-50	1	50	12	493	10	4	115	25	M6	25	45	78	55	M12 X 1.75	12	1/4"	150	4.0
M021-50	2	50	6	493	10	4	115	25	M6	25	45	78	55	M12 X 1.75	12	1/4"	150	4.0
M021-75	2	75	6	543	10	4	115	25	M6	25	45	78	55	M12 X 1.75	12	1/4"	150	4.4
M024-50	2	50	12	589	10	4	115	25	M6	25	45	78	55	M12 X 1.75	12	1/4"	150	6.3
M024-75	2	75	12	639	10	4	115	25	M6	25	45	78	55	M12 X 1.75	12	1/4"	150	6.8
M041-75	4	75	6	584	10	4	125	25	M6	32	55	108	78	M16 X 2	16	1/4"	205	8.8
M044-75	4	75	12	680	10	4	125	25	M6	32	55	108	78	M16 X 2	16	1/4"	205	13.6

'C' Frame Dimensions

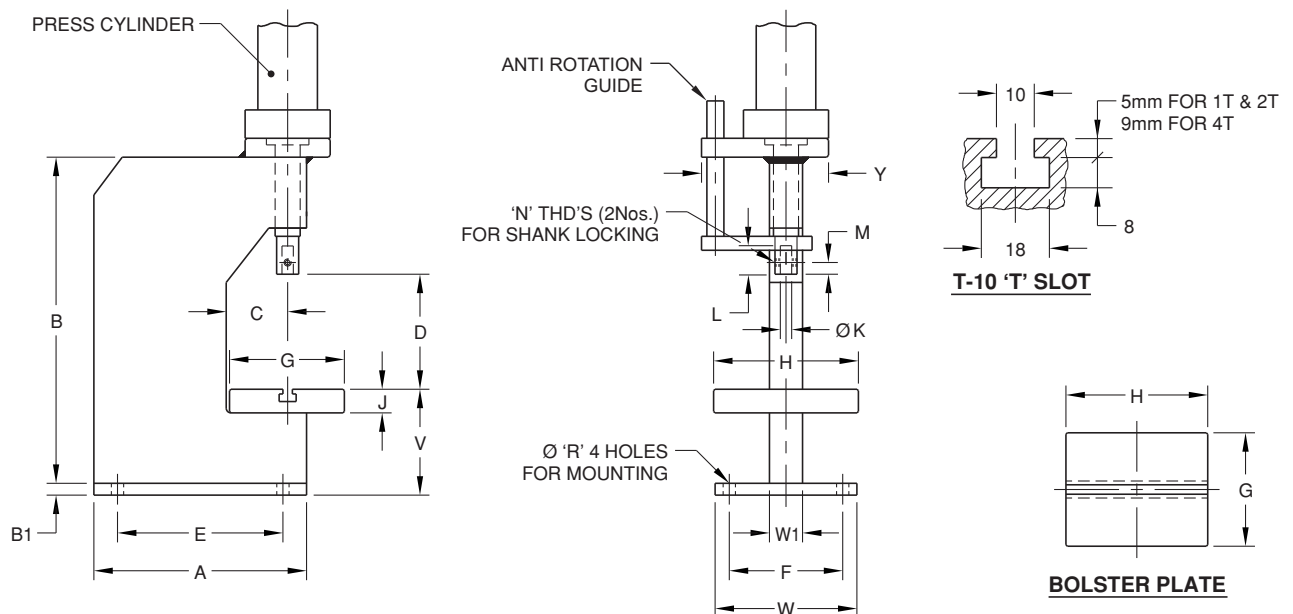

MODEL NO.	TON	A	B	B1	C	D	E	F	G	H	J	ØK	L	M	N	R	T	V	W	W1	Y
3C01HR	1	245	437	12.5	65	200	200	120	120	150	27	12	30	10	M6	13	10	115	150	35	103
3C02HR	2	245	437	12.5	65	200	200	120	120	150	27	12	30	10	M6	13	10	115	150	35	103
3C04HR	4	345	445	15	75	200	300	170	140	200	35	16	30	10	M6	13	10	125	200	50	135



Spare Parts for Series 'M' Manually Operated Hydro Pneumatic Press



VALVE REGULATOR ASSEMBLY

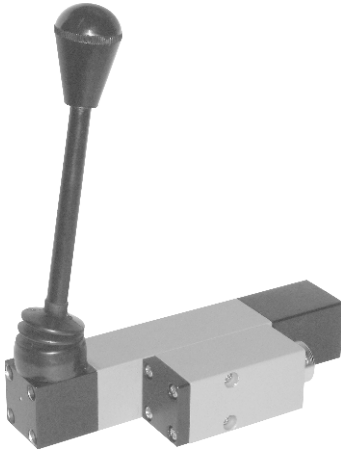

PART No.	DESCRIPTION	SEAL KIT No.
VRA1	VALVE REGULATOR ASSEMBLY	SKVRA1

OIL RESERVOIR



PART No.	DESCRIPTION
102-030	TRANSPARENT RESERVOIR BARREL FOR 1T & 2T CYLINDERS
102-031	TRANSPARENT RESERVOIR BARREL FOR 4T CYLINDER

SPARE SEAL KIT

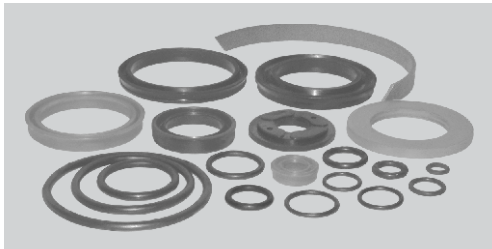

PART No.	DESCRIPTION
90-089	SEAL KIT FOR CYLINDER MODEL No. M021 & M024
90-090	SEAL KIT FOR CYLINDER MODEL No. M041 & M044
90-091	SEAL KIT FOR CYLINDER MODEL No. M014

TONNAGE GAUGE WITH ISOLATOR VALVE



PART No.	DESCRIPTION
88-077	FOR 1T 'N' SERIES CYLINDERS
88-009-2T	FOR 2T 'N' SERIES CYLINDERS
88-009-4T	FOR 4T 'N' SERIES CYLINDERS

ELBOW FLOW CONTROL VALVE



PART No.	DESCRIPTION	SEAL KIT No.
UF2	1/4" SWIVEL ELBOW FLOW CONTROL VALVE	SKUF2