



Special Valves for "Pet Moulding"

1/2" BSP 3/2 Single and Dual Pressure Blow Solenoid Valves

MERCURY

Mechanical Characteristic

Body	Aluminium
Orifice	Ø13.00mm
Ports	G1/2" BSP Female
Seals	Nitrile Rubber
Design	Poppet type, external pilot operated
Weight	Refer to technical data

Operating Conditions

Media	: Air (filtered 40µ & lubricated)
Temperature Range	: +5° to +50°C
Mainline Pressure Range	: 3 to 20 bar
External Pilot Pressure Range	: 5 to 9 bars
Flow (NLPM) at 5 bar	: 3600 Normal litres per min.

Electrical Conditions

Coil Voltage	: 12 & 24 VDC; 24, 48, 110 & 230 VAC / 50 Hz ±10%
Power	: DC - 3 W; AC - 5 VA Hold, 7.5 VA Pickup
Duty Cycle	: Continuous
Response Time	: 15 msec ON / 25 msec OFF
Protection	: IP 65 (as per DIN 40 050)
Connector	: Black (illuminated on request)

* While ordering specify Coil voltage & type of connector. Add voltage & connector suffix as below to model no.

Connector	230VAC	24VAC	12VAC	24VDC	12VDC	110VAC	48VAC
BLACK	A	B	C	D	E	F	G
ILLUMINATED	L	M	N	P	Q	R	S

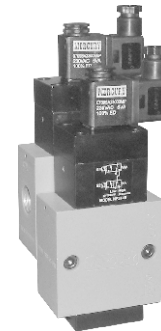
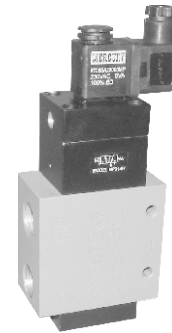

1/2" BSP 3/2 (3 WAY) High Pressure Blow Solenoid Valve

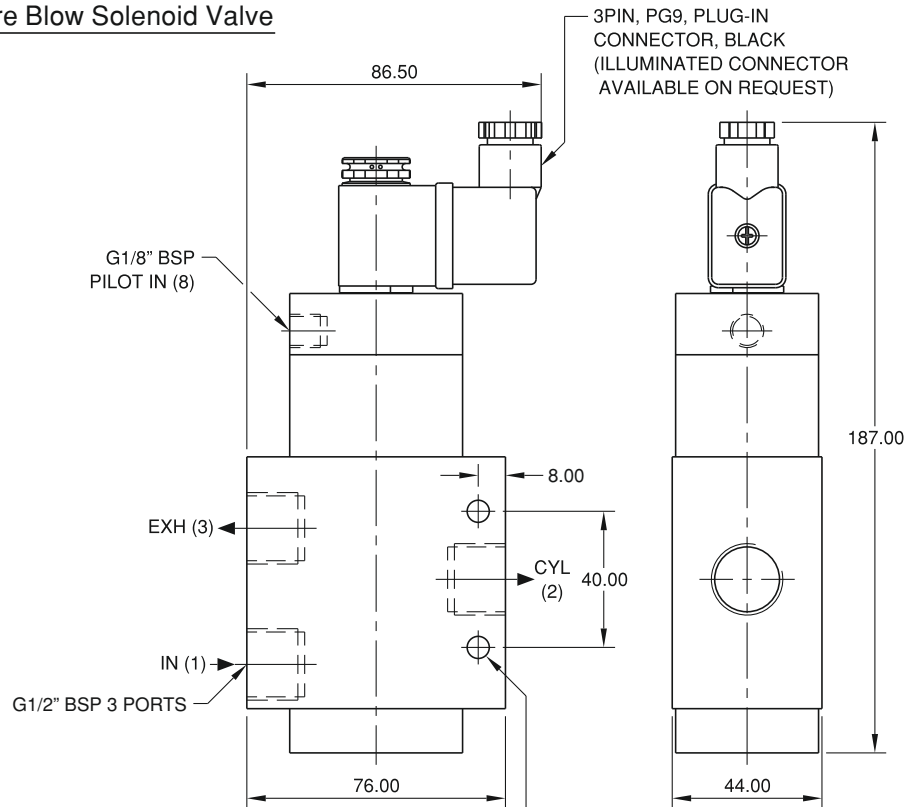
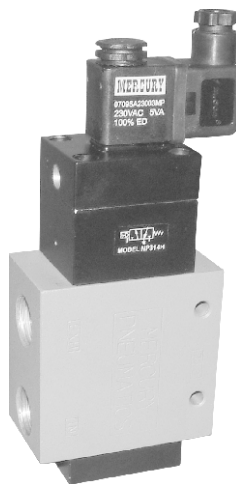

* ADD VOLTAGE & CONNECTOR SUFFIX WHILE ORDERING

MODEL No.	DESCRIPTION	SYMBOL	WEIGHT (Kg.)	SEAL KIT No.
NP314H*	1/2" BSP 3/2 HIGH PRESSURE BLOW SOLENOID VALVE		1.05	SKNP314H

1/2" BSP 3/2 (3 WAY) Dual Pressure Blow Solenoid Valve

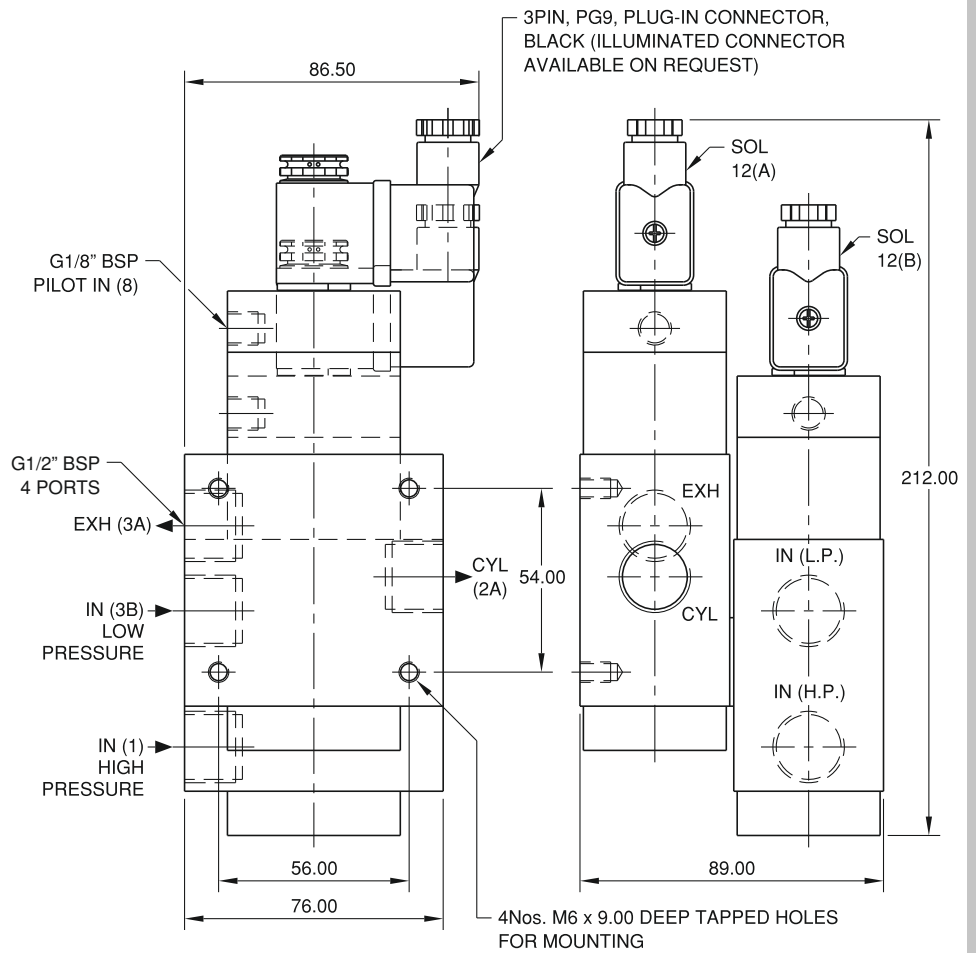
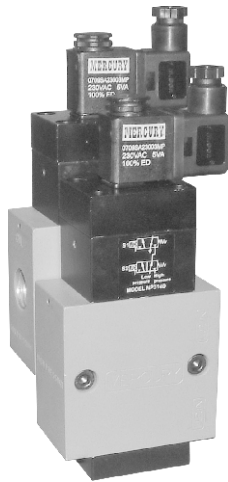

* ADD VOLTAGE & CONNECTOR SUFFIX WHILE ORDERING

MODEL No.	DESCRIPTION	SYMBOL	WEIGHT (Kg.)	SEAL KIT No.
NP314D*	1/2" BSP 3/2 DUAL PRESSURE BLOW SOLENOID VALVE	<p>Low Pressure High Pressure</p>	2.16	SKNP314D

SEQUENCE OF OPERATION

- 1) SOL 12A 'ON' : Low Pressure (3B) is connected to outlet (Cyl 2A) (Low Pressure pre-blow)
- 2) SOL 12A + SOL 12B 'ON' : High Pressure is connected to outlet (Cyl 2A) (High Pressure blow)
- 3) Both SOL 'OFF' : Outlet (Cyl 2A) connected to Exh (3A) (Exhausting)

1/2" & 3/4" BSP 3/2 (3 WAY) Dual Pressure Blow Solenoid Valve

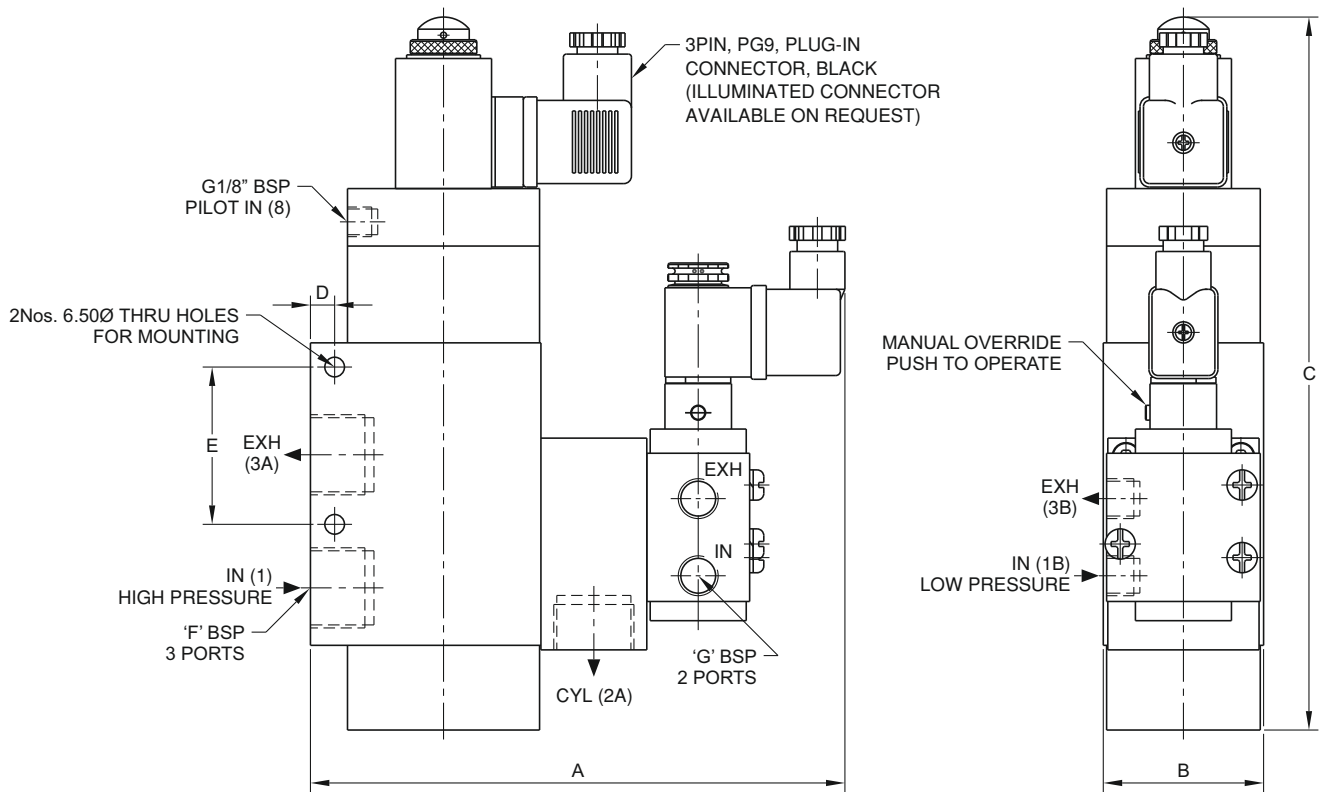
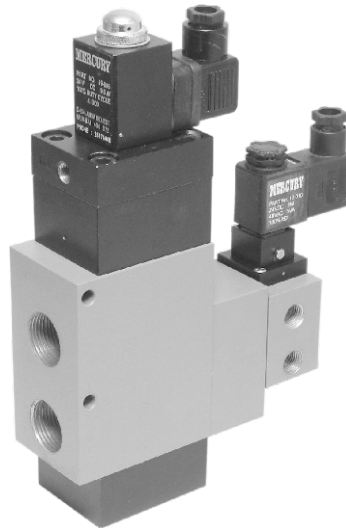

MODEL No.	SIZE	SYMBOL	A	B	C	D	E	F BSP	G BSP	WEIGHT (Kg.)	SEAL KIT No.
SPV1047*	1/2"		174.00	50.80	187.00	13.00	40.00	1/2"	1/4"	1.87	SKSPV1047
SPV1044*	3/4"		177.00	53.00	236.00	8.00	52.00	3/4"	1/4"	2.64	SKSPV1044

ADD VOLTAGE & CONNECTOR SUFFIX WHILE ORDERING



Special Valves for "Pet Moulding"

3/4" & 1" BSP Cushion Solenoid Valve for decelerating mould open-close

MERCURY

Mechanical Characteristic

Body	: Aluminium
Orifice	: Refer to technical data
Ports	: Refer to technical data
Seals	: Nitrile Rubber
Design	: Poppet type, external pilot operated
Weight	: Refer to technical data

Operating Conditions

Media	: Hydraulic oil
Temperature Range	: +5° to +50°C
Mainline Pressure Range	: 2.5 to 10 bar
External Pilot Pressure Range	: 5 to 9 bars

Electrical Conditions

Coil Voltage	: 12 & 24 VDC; 24, 48, 110 & 230 VAC / 50 Hz ±10%
Power	: DC - 3 W; AC - 5 VA Hold, 7.5 VA Pickup
Duty Cycle	: Continuous
Response Time	: 15 msec ON / 25 msec OFF
Protection	: IP 65 (as per DIN 40 050)
Connector	: Black (illuminated on request)

* While ordering specify Coil voltage & type of connector. Add voltage & connector suffix as below to model no.

Connector	230VAC	24VAC	12VAC	24VDC	12VDC	110VAC	48VAC
BLACK	A	B	C	D	E	F	G
ILLUMINATED	L	M	N	P	Q	R	S

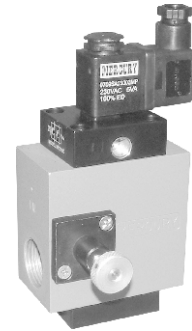

3/4" & 1" BSP 2/2 (2 WAY) Normally Open Cushion Solenoid Valves

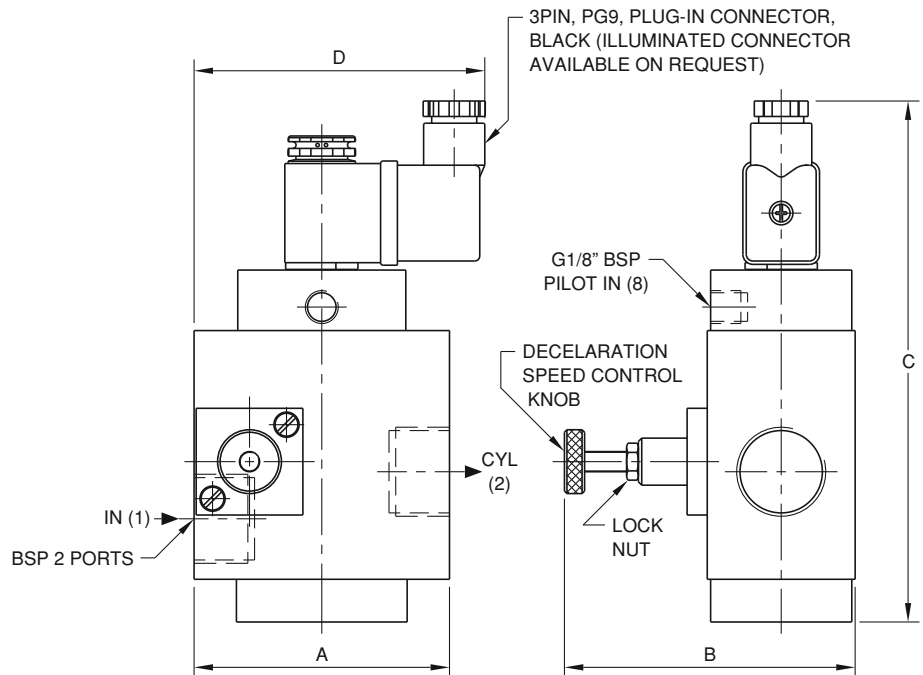
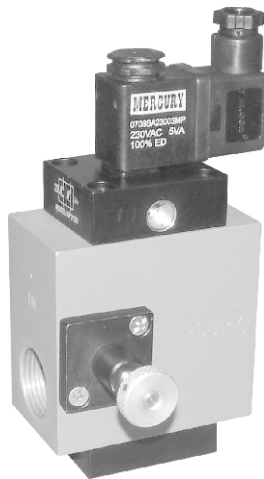

* ADD VOLTAGE & CONNECTOR SUFFIX WHILE ORDERING

MODEL No.	DESCRIPTION	SYMBOL	BSP PORT	A	B	C	D	ORIFICE (mm)	WEIGHT (Kg.)	SEAL KIT No.
NP215C*	3/4" BSP 2/2 NORMALLY OPEN CUSHION SOLENOID VALVE		3/4"	76.00	86.50	157.00	86.50	Ø20.00	0.87	SKNP215C
NP216C*	1" BSP 2/2 NORMALLY OPEN CUSHION SOLENOID VALVE		1"	89.00	95.50	171.00	93.00	Ø24.50	1.24	SKNP216C



Special Valves for "Pet Moulding"

1/2" BSP High Pressure Regulator



Mechanical Characteristic

Body	: Aluminium
Orifice	: Ø12.00mm
Ports	: G1/2" BSP Female
Seals	: Nitrile Rubber
Design	: Piston type, self relieving
Weight	: Refer to technical data

Operating Conditions

Media	: Compressed Air (filtered 40F & lubricated)
Temperature Range	: +5° to +50°C
Pressure Range	: Inlet 5 to 40 bar, Regulated 0 to 40 bar
Leakage	: Bubble Tight
Flow (NLPM) at 5 bar	: 2500 Normal litres per min.

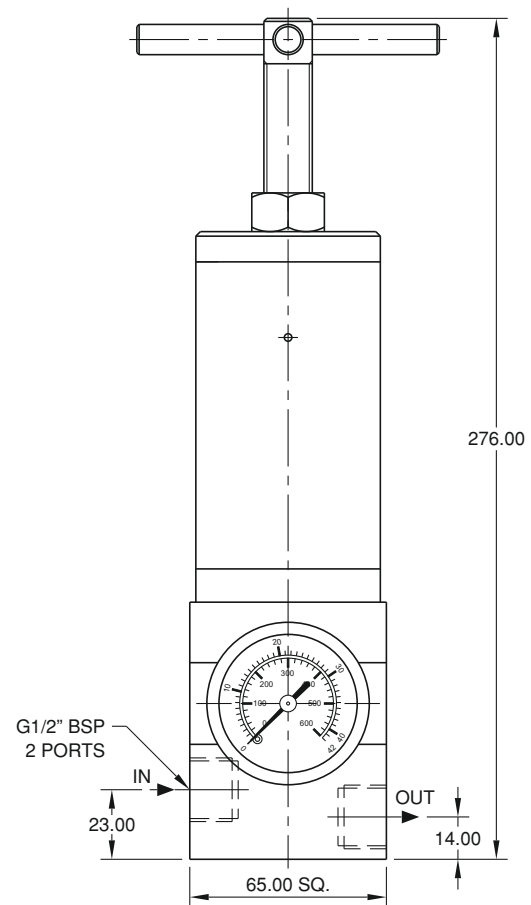

3Nos. M6 x 10.00 DEEP TAPPED HOLES FOR MOUNTING

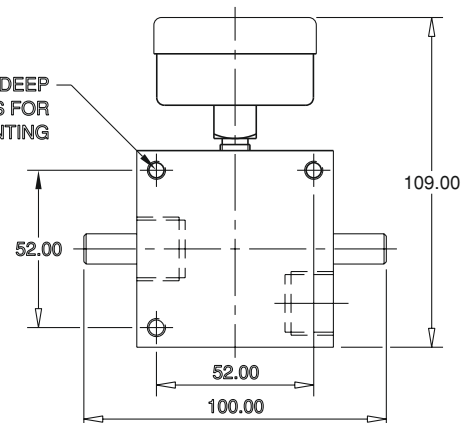

MODEL No.	DESCRIPTION	SYMBOL	WEIGHT (Kg.)	SEAL KIT No.
RH4	G1/2" BSP HIGH PRESSURE REGULATOR WITH PRESSURE GAUGE		3.12	SKRH4



Special Valves for "Pet Moulding"

1" BSP High Pressure Regulator



Mechanical Characteristic

Body	: Aluminium
Orifice	: Ø24.50mm
Ports	: G1" BSP Female
Seals	: Nitrile Rubber
Design	: Piston type, self relieving
Weight	: Refer to technical data

Operating Conditions

Media	: Compressed Air (filtered 40µ & lubricated)
Temperature Range	: +5° to +50°C
Pressure Range	: Inlet 5 to 40 bar, Regulated 0 to 40 bar
Leakage	: Bubble Tight
Flow (NLPM) at 5 bar	: 10000 Normal liters per min.

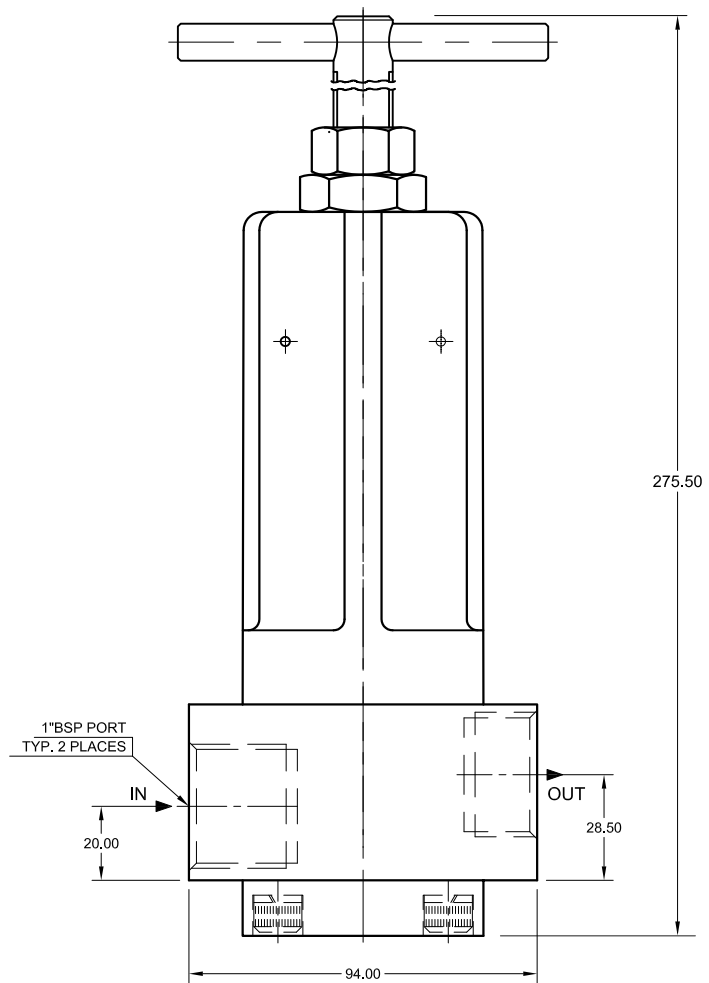

4 Nos. M6 THRD'S x 9.00 DEEP ON 50 P.C.D
EQUISPACED ON 90° FOR MOUNTING

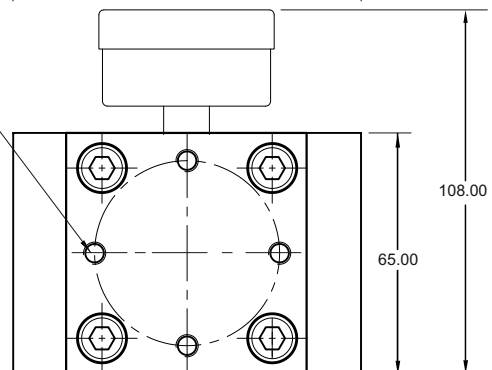

MODEL No.	DESCRIPTION	SYMBOL	WEIGHT (Kg.)	SEAL KIT No.
RH6	G1" BSP HIGH PRESSURE REGULATOR WITH PRESSURE GAUGE		3.50	SKRH6