

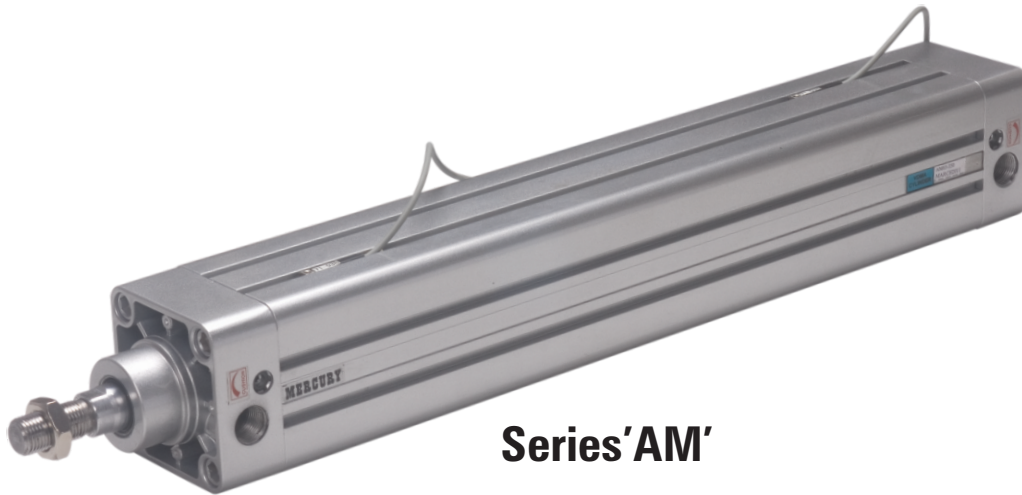

MERCURY

Leadership through innovation

Pneumatic Cylinders



Series 'AM'

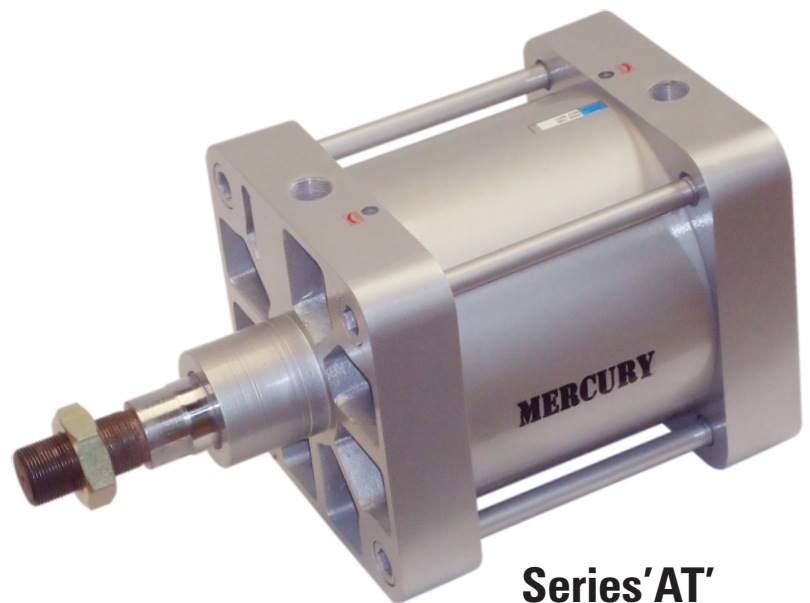

Series 'AT'



Mercury Pneumatics Pvt. Ltd.

C-105, Ansa Industrial Estate, Saki Vihar Rd, Andheri (E),
Mumbai - 400072, India. Phone: +91-22-40344200

E-mail: mercurypneumatics@vsnl.net Website: www.mercuryindia.net

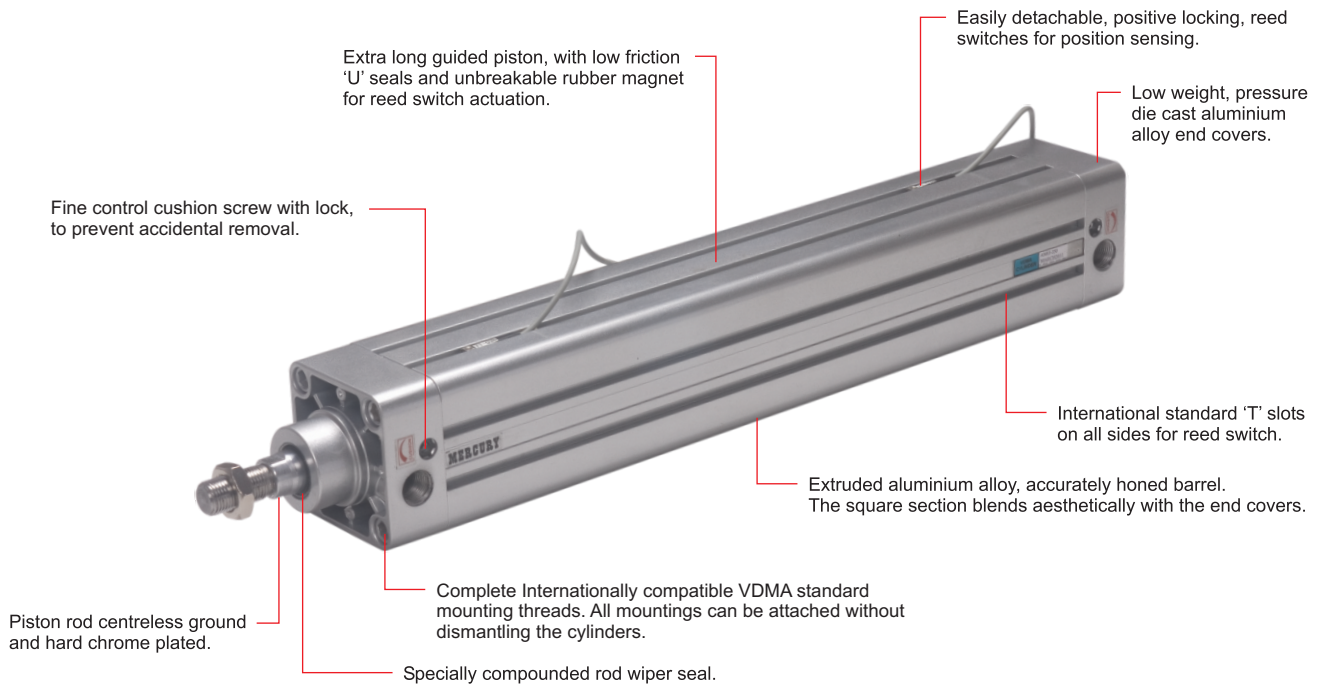

BASIC DIMENSIONS

SINGLE ENDED

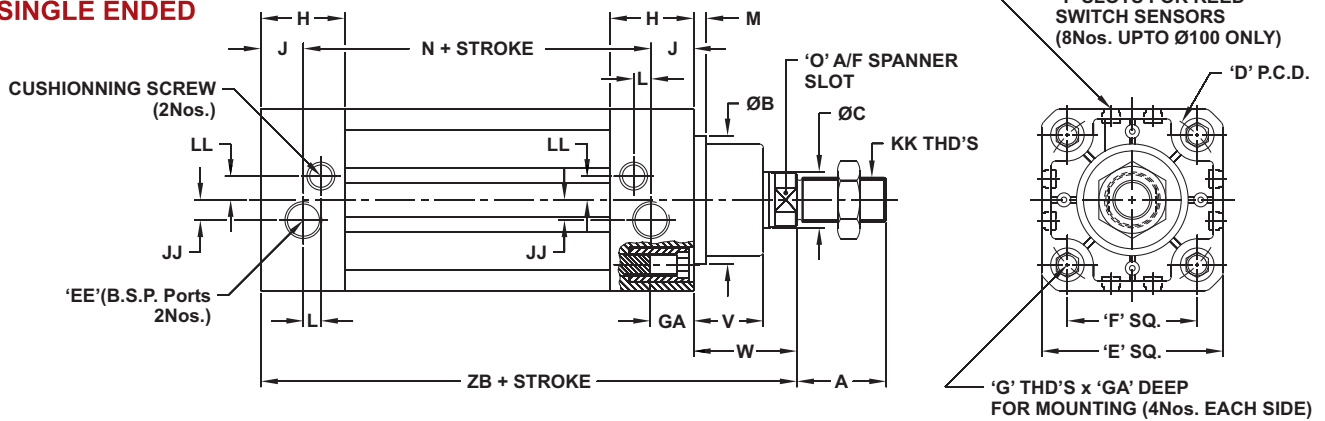

DOUBLE ENDED

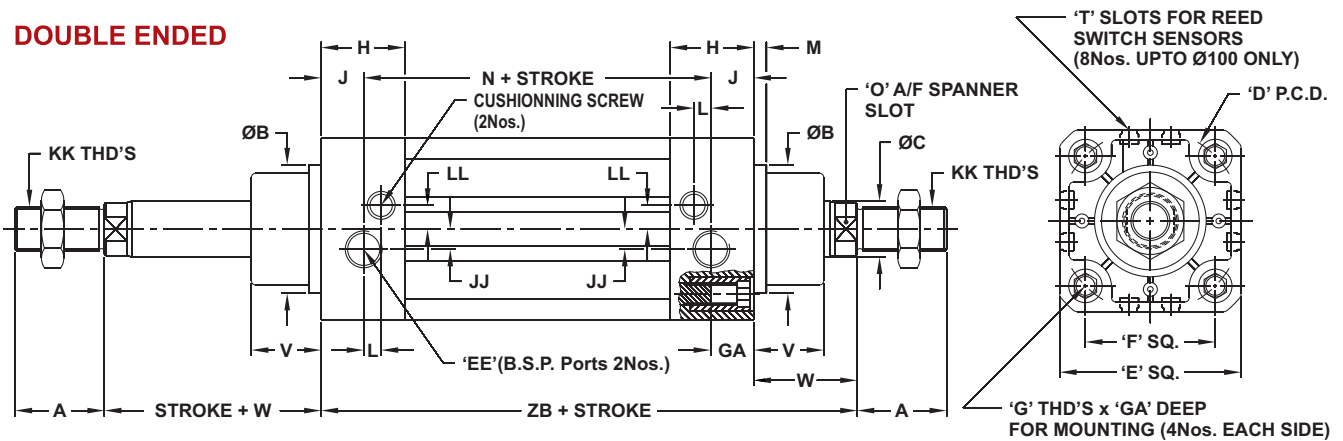

MODEL No.	PISTON DIA(mm)	A	ØB	ØC	D P.C.D.	E	EE B.S.P.	F	G	GA	H	J	JJ	KK	L	LL	M	N	O	V	W	ZB
AM 32	32	22	30	12	46	47	G1/8"	32.5	M6	16	27.5	14	4	M10 x 1.25	6	7	-	66	10	16	26	120
AM 40	40	24	35	16	53.7	53	G1/4"	38	M6	16	29	14.5	6	M12 x 1.25	6.5	8.5	-	76	13	18	30	135
AM 50	50	32	40	20	65.8	65	G1/4"	46.5	M8	17	30	15	7	M16 x 1.5	6.5	8.5	-	75	17	25	37	143
AM 63	63	32	45	20	80	75	G3/8"	56.5	M8	17	31	15.5	9	M16 x 1.5	7	8	4	89	17	24	37	158
AM 80	80	40	45	25	101.8	95	G3/8"	72	M10	18	35	17.5	11.5	M20 x 1.5	9	13.5	-	93	22	30	46	174
AM 100	100	40	55	25	126	115	G1/2"	89	M10	18	36	18	14	M20 x 1.5	10	14.5	4	102	22	32	51	189
AT 125	125	54	60	32	155.6	140	G1/2"	110	M12	20.5	46	23	14	M27 x 2	14	14	10	114	27	45	65	225
AT 160	160	72	65	40	198	180	G3/4"	140	M16	23	50	25	14	M36 x 2	14	21	10	130	36	58	80	260
AT 200	200	72	75	40	247	220	G3/4"	175	M16	23	50	25	-	M36 x 2	-	-	12	130	36	57	95	275

● STANDARD STROKES STOCKED FOR QUICK DELIVERY : 25, 50, 80, 100, 125, 160, 200, 250 mm.

Cylinder Mountings

CLEVIS FOOT

PART No.	CYL BORE	A1	A2	A3	B1	B2	C1	C2	CB	ØCD	ØFB	MR
71-003-01	Ø32	21	18	31	38	51	8	32	26	10	6.5	10
71-003-02	Ø40	24	22	35	41	54	10	36	28	12	6.5	12
71-003-03	Ø50	33	30	45	50	65	12	45	32	12	9	13
71-003-04	Ø63	37	35	50	52	67	12	50	40	16	9	15
71-003-05	Ø80	47	40	60	66	86	14	63	50	16	11	15
71-003-06	Ø100	55	50	70	76	96	15	71	60	20	11	19
71-003-07	Ø125	70	60	90	94	124	20	90	70	25	14	25
71-003-08	Ø160	97	88	126	118	156	25	115	90	30	14	32
71-003-09	Ø200	105	90	130	122	162	25	135	90	30	16	32

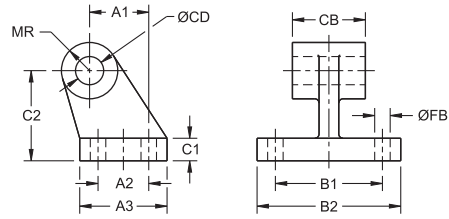

PIVOT FLANGE

PART No.	CYL BORE	C	CB	ØCD	E	L	L1	MR	UB	XD
71-032-01	Ø32	54	26	10	46	13	22	10.5	45	142
71-032-02	Ø40	62	28	12	52	16	25	13	52	160
71-032-03	Ø50	70	32	12	65	16	27	13	60	170
71-032-04	Ø63	82	40	16	75	21	32	17	70	190
71-032-05	Ø80	102	50	16	95	22	36	18	90	210
71-032-06	Ø100	126	60	20	114	27	41	23	110	230
71-032-07	Ø125	150	70	25	140	30	50	26	130	275
71-032-08	Ø160	192	90	30	180	35	55	31	170	315
71-032-09	Ø200	192	90	30	220	35	60	31	170	335

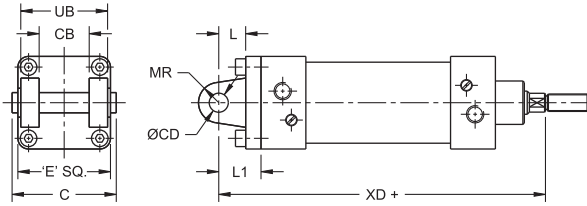

SINGLE EARRING

PART No.	CYL BORE	A	B	CB	ØCD	L	L1	MR
71-043-01	Ø32	47	32.5	25.8	10	13	22	9
71-043-02	Ø40	53	38	27.8	12	16	25	12
71-043-03	Ø50	65	46.5	31.7	12	17	27	12
71-043-04	Ø63	75	56.5	39.7	16	22	32	15
71-043-05	Ø80	95	72	49.7	16	22	36	15
71-043-06	Ø100	115	89	59.7	20	27	41	20
71-043-07	Ø125	139	110	69.7	25	32.5	49.5	29.5

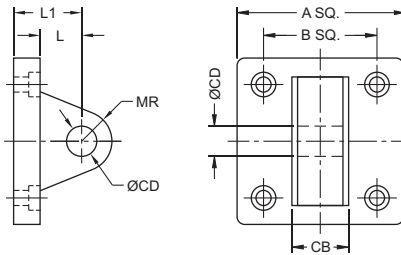

ANGLE BRACKET

PART No.	CYL BORE	ØAB	AH	AO	B1	B2	C	D	SA	TR	XA
71-031-01	Ø32	7	32	11	55	46	4	24	142	32	144
71-031-02	Ø40	9	36	8	62	52	4	28	161	36	163
71-031-03	Ø50	9	45	15	77.5	65	5	32	170	45	175
71-031-04	Ø63	9	50	13	87.5	75	5	32	185	50	190
71-031-05	Ø80	12	63	14	110.5	95	6	41	210	63	215
71-031-06	Ø100	14	71	16	128	114	6	41	220	75	230
71-031-07	Ø125	16	90	16	160	140	8	45	250	90	270
71-031-08	Ø160	18	115	25	205	180	10	60	300	115	320
71-031-09	Ø200	22	135	25	245	220	15	70	320	135	345

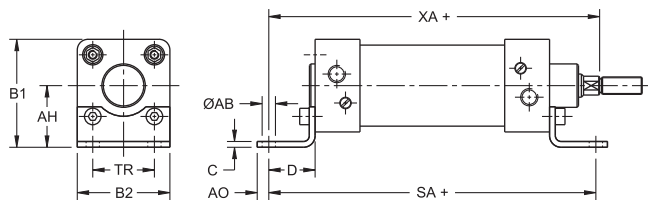

FLANGE

PART No.	CYL BORE	C	E	ØFB	R	TF	UF	W	ZF	ZB
71-033-01	Ø32	10	50	7	32	64	80	16	130	120
71-033-02	Ø40	10	60	9	36	72	90	20	145	135
71-033-03	Ø50	12	63.5	9	45	90	110	25	155	143
71-033-04	Ø63	12	76	9	50	100	125	25	170	158
71-033-05	Ø80	16	101.6	12	63	126	154	30	190	174
71-033-06	Ø100	16	114	14	75	150	175	35	205	189
71-033-07	Ø125	25	140	16	90	180	220	45	245	225
71-033-08	Ø160	25	180	18	115	230	280	60	280	260
71-033-09	Ø200	25	220	22	135	270	320	70	300	275

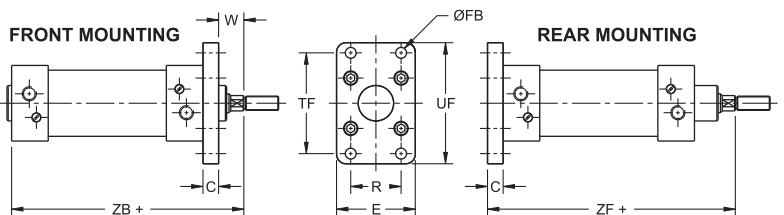

INTERMEDIATE TRUNNION WITH MOUNTING BRACKET

PART No.	CYL BORE	A	B	C	ØD	E	F	ØG	H	J	K	L	TL	TM	ØTD	UW	XV
71-034-01	Ø32	86	71	30	11	7	30	7	15	32	46	18	12	50	12	65	73
71-034-02	Ø40	105	87	32	15	9	36	9	18	36	55	21	16	63	16	75	82.5
71-034-03	Ø50	117	99	34	15	9	36	9	18	36	55	21	16	75	16	95	90
71-034-04	Ø63	136	116	41	18	11	40	11	20	42	65	23	20	90	20	105	97.5
71-034-05	Ø80	156	136	44	18	11	40	11	20	42	65	23	20	110	20	130	110
71-034-06	Ø100	189	164	48	20	13	50	14	25	50	75	28.5	25	132	25	145	120
71-034-07	Ø125	217	192	42	20	13	50	14	25	50	75	28.5	25	160	25	144	145
71-034-08	Ø160	280	245	50	26	17.5	60	18	35	60	92	39	32	200	32	185	170
71-034-09	Ø200	330	295	50	26	17.5	60	18	35	60	92	39	32	250	32	227	185

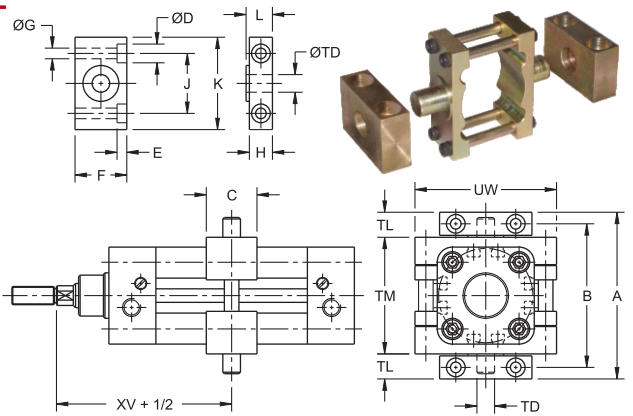

ROD CLEVIS

PART No.	CYL BORE	A	B1	B2	CE	ØCK	CM	ØD	E	ER	KK	LE	SW
71-007-01	Ø32	20	20	26	40	10	10	18	5	12	M10 X 1.25	20	17
71-007-02	Ø40	24	25.4	31	48	12	12	20	6	14	M12 X 1.25	24	19
71-007-03	Ø50, Ø63	32	31.7	39	64	16	16	26	8	19	M16 X 1.5	32	24
71-007-04	Ø80, Ø100	40	38	53	80	20	20	34	10	25	M20 X 1.5	40	30
71-007-05	Ø125	50	50	68.5	100	25	25	42	13.5	32	M27 X 2	50	41
71-007-06	Ø160, Ø200	56	74	90.5	144	35	35	60	18	44	M36 X 2	72	55

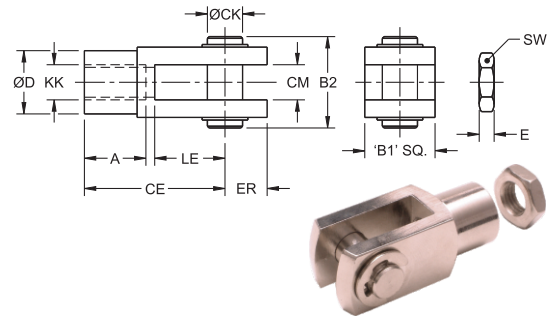

SWIVEL ROD EYE

PART No.	CYL BORE	A	CE	ØCN	E	EL	EN	ER	KK	SW1	SW
71-008-01	Ø32	21	43	10	5	11	14	13	M10 X 1.25	17	17
71-008-02	Ø40	24	50	12	6	12	16	15	M12 X 1.25	19	19
71-008-03	Ø50, Ø63	33	64	16	8	15	21	19	M16 X 1.5	22	24
71-008-04	Ø80, Ø100	40	77	20	10	18	25	23	M20 X 1.5	32	30

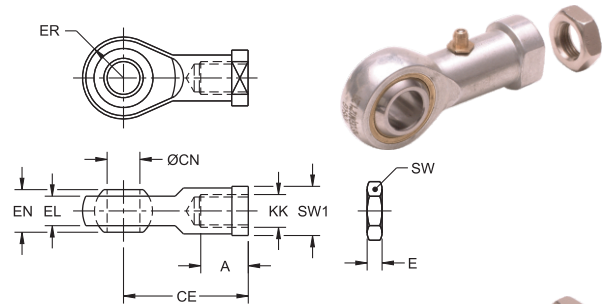

ROD EYE

PART No.	CYL BORE	A	B1	CE	ØCK	CM	ØD	E	ER	KK	SW
71-009-01	Ø32	18	-	40	10	10	20	5	12	M10 X 1.25	17
71-009-02	Ø40	19	-	48	12	12	24	6	14	M12 X 1.25	19
71-009-03	Ø50, Ø63	26	-	64	16	16	32	8	19	M16 X 1.5	24
71-009-04	Ø80, Ø100	34	-	80	20	20	40	10	25	M20 X 1.5	30
71-009-05	Ø125	42	-	110	30	30	54	13.5	32	M27 X 2	41
71-009-06	Ø160, Ø200	62	76 SQ.	144	35	35	60	18	44	M36 X 2	55

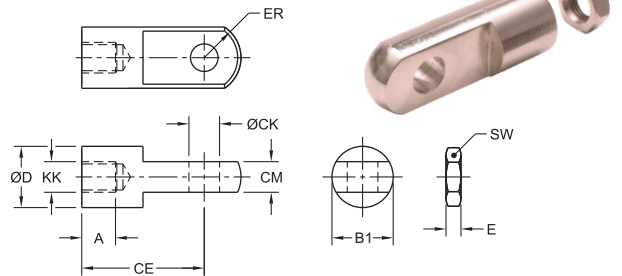

SELF ALIGNING ROD COUPLING

PART No.	CYL BORE	A	B	ØD1	ØD2	E	SW1	SW2	SW3	KK
71-010-01	Ø32	55	20	25	12	5	17	11	22	M10 X 1.25
71-010-02	Ø40	67.5	24	32	16	6	19	13	29	M12 X 1.25
71-010-03	Ø50, Ø63	82.5	32	40	20	8	24	17	36	M16 X 1.5
71-010-04	Ø80, Ø100	100.5	40	50	25	10	30	22	46	M20 X 1.5
71-010-05	Ø125	132	48	70	32	13.5	41	27	60	M27 X 2
71-010-06	Ø160, Ø200	183	72	93	45	18	55	41	85	M36 X 2

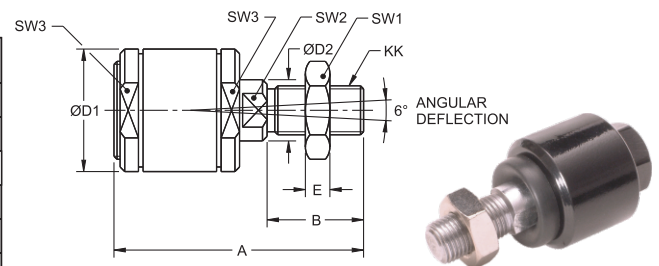

REED SWITCH

PART No.	TYPE : NORMALLY OPEN INDICATION : LED VOLTAGE : 10 TO 30V DC MAX. VOLTAGE DROP : 2 V CONNECTION : 3 WIRE PROTECTION : IP67
71-036 & 71-037	

PART No.	TYPE : NORMALLY OPEN INDICATION : LED VOLTAGE : 5 TO 240V DC/AC MAX. VOLTAGE DROP : 3 V CONNECTION : 2 WIRE PROTECTION : IP67
71-038	

